

F-401U

Electrical Specifications (@25C)

1. Maximum Power: 240.0 VA
2. Primary: 115V 50/60 Hz
3. Secondary: 24.0VCT @ 10.0 Amps
4. Voltage Regulation: 10 % TYP @ full load to no load
5. Temperature Rise: 35C TYP (45C MAX allowed)

Description:

The F-401U is part of a series which has a long history of reliable service in the field, made from a proven design and constructed with UL recognized materials.

Construction:

Wound on a single channel nylon bobbin. Materials are UL recognized, Class B (130° C) rated.

Safety:

These products are 100% hipot tested with an insulation of 1500V between primary and secondary windings as well as between the primary / secondary windings and the core.

Dimensions:

Units: In inches

A	B	C	D	E
4.125	3.437	3.750	2.750	3.00

Lead length: 7.0 inches \pm 1 inch

Weight: 8.0 lbs

Schematic:

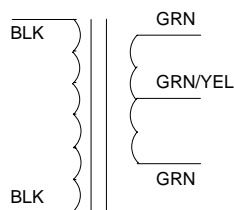

Primary: Black to Black
Secondary: Green to Green

RoHS Compliance: As of manufacturing date February 2005, all standard products meet the requirements of 2002/95/EC, known as the RoHS initiative.

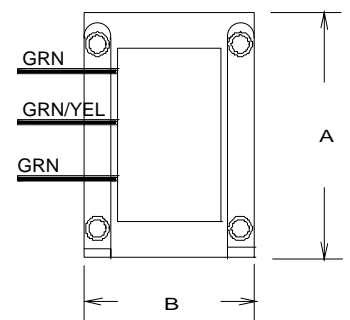
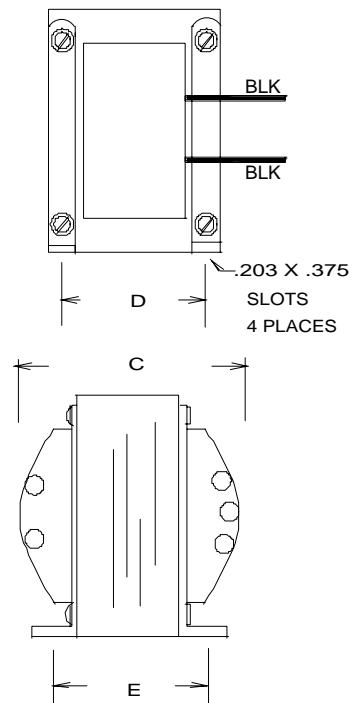
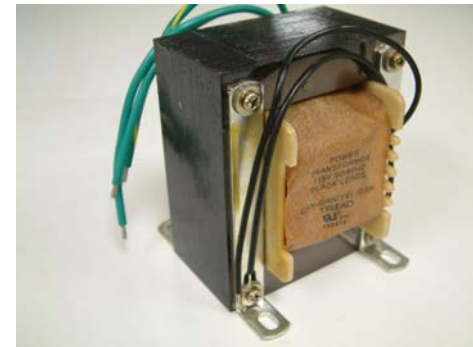

Power Transformers

Chassis Mount: Single Secondary

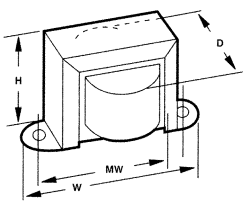

Case Type X

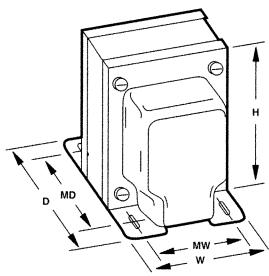

Case Type A

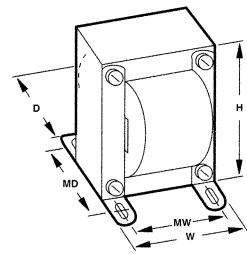

Case Type U

:: Description

Triad offers a full choice of power supply transformers for direct use or in transformer, rectifier, or filter circuits. Other available secondary voltages include control, filament and low level signaling in standard values. The transformers are single primary with single and multiple secondaries in standard size and weight configurations.

:: Specifications

Primary: 115/230 V, 50/60 Hz

:: Single Secondary

	Type No.	Secondary Volts	Secondary Amps	Primary Voltage	RMS Test Voltage (Sec.)	Case Type	Connections	Dimensions			Mounting Dimensions		Wt. Lbs.
								H	W	D	MW	MD	
A	F-1X#	2.5 CT	3.0	115	1,500	X	Leads	1 $\frac{1}{8}$	2 $\frac{3}{16}$	1 $\frac{1}{8}$	2 $\frac{3}{8}$	•	0.68
	F-301X	2.5 CT	3.0	115/230	1,500	X	Leads	1 $\frac{1}{8}$	2 $\frac{3}{16}$	1 $\frac{1}{8}$	2 $\frac{3}{8}$	•	0.68
	F-6X#	2.5 CT	6.0	115	2,500	X	Leads	1 $\frac{1}{2}$	3 $\frac{3}{16}$	1 $\frac{3}{4}$	2 $\frac{3}{16}$	•	1.00
	F-3X#	2.5 CT	10.0	115	3,000	X	Leads	2 $\frac{1}{2}$	3 $\frac{3}{4}$	2 $\frac{1}{8}$	3 $\frac{3}{8}$	•	1.70
B	F-7X	5.0 CT	3.0	115	1,500	X	Leads	1 $\frac{1}{2}$	3 $\frac{3}{16}$	2	2 $\frac{3}{16}$	•	1.30
	F-8X	5.0 CT	6.0	115	1,500	X	Leads	2 $\frac{1}{2}$	3 $\frac{3}{4}$	2 $\frac{1}{8}$	3 $\frac{3}{8}$	•	1.70
	F-12X	5.0 CT	8.0	115	2,500	X	Leads	2 $\frac{1}{2}$	4	2 $\frac{1}{4}$	3 $\frac{3}{16}$	•	2.50
C	F-13X	6.3	0.6	115	1,500	X	Leads	1 $\frac{1}{8}$	2 $\frac{3}{8}$	1 $\frac{1}{8}$	2	•	0.37
	F-313X	6.3	0.6	115/230	1,500	X	Leads	1 $\frac{1}{8}$	2 $\frac{3}{8}$	1 $\frac{1}{8}$	2	•	0.37
	F-14X#	6.3 CT	1.2	115	2,500	X	Leads	1 $\frac{1}{8}$	2 $\frac{3}{16}$	1 $\frac{1}{8}$	2 $\frac{3}{8}$	•	0.70
	F-314X	6.3 CT	1.2	115/230	2,500	X	Leads	1 $\frac{1}{8}$	2 $\frac{3}{16}$	1 $\frac{1}{8}$	2 $\frac{3}{8}$	•	0.70
	F-16X	6.3 CT	3.0	115	2,500	X	Leads	1 $\frac{1}{2}$	3 $\frac{3}{16}$	2	2 $\frac{3}{16}$	•	1.30
	F-316X	6.3 CT	3.0	115/230	2,500	X	Leads	1 $\frac{1}{2}$	3 $\frac{3}{16}$	2	2 $\frac{3}{16}$	•	1.30
	F-43X#	6.3	4.0	115	1,500	X	Leads	1 $\frac{1}{2}$	3 $\frac{3}{16}$	2	2 $\frac{3}{16}$	•	1.25
	F-18X	6.3 CT	6.0	115	1,500	X	Leads	2 $\frac{1}{2}$	4	2 $\frac{1}{4}$	3 $\frac{3}{16}$	•	2.30
	F-318X	6.3 CT	6.0	115/230	1,500	X	Leads	2 $\frac{1}{2}$	4	2 $\frac{1}{4}$	3 $\frac{3}{16}$	•	2.30
	F-69X	6.3 CT	8.0	115	1,500	X	Leads	2 $\frac{1}{2}$	4	2 $\frac{1}{4}$	3 $\frac{3}{16}$	•	2.30
	F-21A	6.3 CT	10.0	115	1,500	A	1-Leads	3 $\frac{3}{32}$	2 $\frac{3}{32}$	3 $\frac{3}{8}$	2 $\frac{1}{4}$	2	3.80
F-22A	6.3 CT	20.0	115	2,000	A	2-Leads	3 $\frac{3}{8}$	3 $\frac{3}{32}$	4 $\frac{1}{8}$	2 $\frac{1}{2}$	3	7.00	
D	F-28U†	7.5 CT or 6.3 CT	25.0	115	3,000	U	Leads & Lugs	4 $\frac{1}{8}$	3 $\frac{3}{16}$	3 $\frac{3}{8}$	3	3 $\frac{3}{16}$	7.50
E	F-180X	10.0 CT	1.0	115	1,500	X	Leads	1 $\frac{1}{2}$	3 $\frac{3}{16}$	1 $\frac{1}{4}$	2 $\frac{3}{16}$	•	0.90
	F-31X	10.0 CT	3.0	115	2,000	X	Leads	2 $\frac{1}{2}$	3 $\frac{3}{4}$	2 $\frac{1}{8}$	3 $\frac{3}{8}$	•	1.70

60 Hz †Tapped primary to produce lower voltages CT = Center Tap Mounting hole sizes: X = $\frac{3}{16}$ " U = $\frac{13}{64}$ x $\frac{3}{8}$ " A = $\frac{3}{8}$ x $\frac{3}{16}$ "

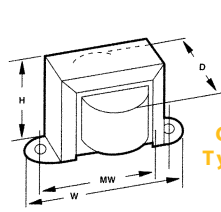

Case Type X

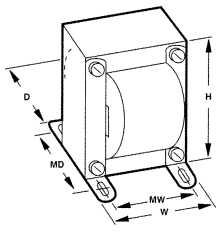

Case Type U

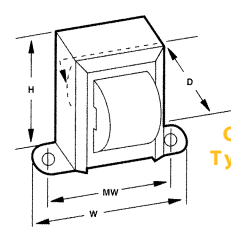

Case Type Z

:: Single Secondary continued

Section	Type No.	Secondary		Primary Voltage	RMS Test Voltage (Sec.)	Case Type	Connections	Dimensions			Mounting Dimensions		Wt. Lbs.
		Volts	Amps					H	W	D	MW	MD	
A	F-96U	10.0 CT	6.000	115	1,500	U	Leads	3	2½	2¾	2	2¾	2.10
	F-97U	10.0 CT	8.000	115	1,500	U	Leads	3½	2¾	3	2½	2½	4.00
B	F-113X	12.0	0.150	115	1,500	X	Leads	1¾	2¾	1¾	2	•	0.40
	F-216X#	12.0	0.350	115	1,500	X	Leads	1¾	2¾	1¾	2	•	0.37
	F-114X	12.0	0.700	115	1,500	X	Leads	1¾	2¾	1¾	2¾	•	0.80
	F-217X#	12.0	1.200	115	1,500	X	Leads	2	3¼	1¾	2¾	•	1.00
	F-218X#	12.0	2.000	115	1,500	X	Leads	2	3¼	1¾	2¾	•	1.13
	F-219X#	12.0	4.000	115	1,500	X	Leads	2¾	4	2¼	3¾	•	2.30
	F-220U#	12.0	6.000	115	1,500	U	Leads	3¾	2¾	2½	2¼	2¾	3.50
	F-221U#	12.0	8.000	115	1,500	U	Leads	3¾	3¾	2¾	2½	2¾	4.00
C	F-29U†	12.0 CT or 11.0 CT or 10.0 CT	11.0	115	3,000	U	Leads	4¾	3½	3¾	2¾	2¾	6.50
D	F-70X	12.6 CT	1.000	115	1,500	X	Leads	1¾	3¾	1¾	2¾	•	1.30
	F-25X	12.6 CT	1.500	115	1,500	X	Leads	1¾	3¾	2	2¾	•	1.30
	F-325X	12.6 CT	1.500	115/230	1,500	X	Leads	1¾	3¾	2	2¾	•	1.30
	F-44X#	12.6 CT	2.000	115	1,500	X	Leads	1¾	3¾	2	2¾	•	1.25
	F-344X	12.6 CT	2.000	115/230	1,500	X	Leads	1¾	3¾	2	2¾	•	1.25
	F-26X#	12.6 CT	2.500	115	1,500	X	Leads	2¾	3¾	2	3¾	•	1.55
	F-326X	12.6 CT	2.500	115/230	1,500	X	Leads	2¾	3¾	2	3¾	•	1.55
	F-224X#	12.6	3.000	115	1,500	X	Leads	2¼	3¼	2¾	3¾	•	1.60
	F-225X#	12.6	4.000	115	1,500	X	Leads	2¾	4	2¾	3¾	•	2.30
	F-3181U	12.6 CT	4.000	115/230	1,500	U	Leads	3¾	2¾	2¾	2	2	2.30
	F-182U	12.6 CT	6.000	115	1,500	U	Leads	3¾	2¾	1¾	2¼	2¾	3.80
	F-183U	12.6 CT	8.000	115	1,500	U	Leads	3¾	3¾	2¾	2½	2¼	5.00
E	F-112X	14.0 CT	0.250	115	1,500	X	Leads	1¾	2¾	1¾	2	•	0.40
	F-3112X	14.0 CT	0.250	115/230	1,500	X	Leads	1¾	2¾	1½	2	•	0.30
	F-250X	14.0 CT	1.000	115	1,500	X	Leads	1¾	3¾	1¾	2¾	•	1.20
	F-251X	14.0 CT	2.000	115	1,500	X	Leads	2¼	3¾	1¾	2¾	•	1.50
	F-252U	14.0 CT	4.000	115	1,500	U	Leads	3	2½	2¾	2	2¼	3.00
	F-253U	14.0 CT	6.000	115	1,500	U	Leads	3¾	2¾	2¾	2¼	2¾	4.00
F	F-254X	20.0 CT	1.000	115	1,500	X	Leads	2¼	3¾	1¾	3¾	•	1.50
	F-255X	20.0 CT	2.000	115	1,500	X	Leads	2¾	4	2¼	3¾	•	2.50
	F-256U	20.0 CT	4.000	115	1,500	U	Leads	3¾	2¾	2¾	2¾	•	4.00
	F-257U	20.0 CT	6.000	115	1,500	U	Leads	3¾	3¾	3¾	2½	2¾	5.70
	F-258U	20.0 CT	8.000	115	1,500	U	Leads	3¾	3¾	3½	2½	2¾	6.40
	F-259U	20.0 CT	10.000	115	1,500	U	Leads	4¾	3¾	3½	2¾	2¾	7.40
G	F-115X	24.0 CT	0.085	115	1,500	X	Leads	1¾	2¾	1¾	1¾	•	0.30
	F-3115X	24.0 CT	0.085	115/230	1,500	X	Leads	1¾	2¾	1¾	1¾	•	0.30
	F-116X	24.0 CT	0.200	115	1,500	X	Leads	1¾	2¾	1½	2	•	0.45
	F-3116X	24.0 CT	0.200	115/230	1,500	X	Leads	1¾	2¾	1½	2	•	0.45
	F-117X	24.0 CT	0.400	115	1,500	X	Leads	1¾	2¾	1¾	2¾	•	0.80
	F-3117X	24.0 CT	0.400	115/230	1,500	X	Leads	1¾	2¾	1½	2¾	•	0.75
	F-118X	24.0 CT	0.700	115	1,500	X	Leads	2	3¼	2	2¾	•	1.30
	F-3118X	24.0 CT	0.700	115/230	1,500	X	Leads	2	3¼	2	2¾	•	1.30
	F-45X#	24.0 CT	1.000	115	1,500	X	Leads	1¾	3¾	2	2¾	•	1.30
	F-345X	24.0 CT	1.000	115/230	1,500	X	Leads	1¾	3¾	2	2¾	•	1.30
	F-46X#	24.0	1.000	115	1,500	X	Leads	1¾	3¾	2¾	2¾	•	1.40
	F-229X#	24.0	2.000	115	1,500	X	Leads	2¾	4	2	3¾	•	2.30
	F-192X	24.0 CT	2.000	115	1,500	X	Leads	2¾	4	2¼	3¾	•	2.30
	F-193U	24.0 CT	4.000	115	1,500	U	Leads	2¾	3¾	2¾	2½	2¾	4.00
	F-260U	24.0 CT	6.000	115	1,500	U	Leads	3¾	3¾	3½	2½	2¾	6.40
	F-261U	24.0 CT	8.000	115	1,500	U	Leads	4¾	3¾	3½	2¾	2¾	7.40
	F-401U	24.0 CT	10.000	115	1,500	U	Leads	4¾	3¾	3¾	2¾	3	8.00
	F-226U#	24.0 CT	12.000	115	1,500	U	Leads	4¾	3¾	4¾	3	3¾	10.40
F-1000U	24.0 CT	21.000	115/230	1,500	U	Leads	4¾	3¾	4¾	3	3¾	10.40	

60 Hz †Tapped primary to produce lower voltages CT = Center Tap Mounting hole sizes: U = 1/64 x 3/8" X = 3/16"

:: Single Secondary continued

Section	Type No.	Secondary		Primary Voltage	RMS Test Voltage (Sec.)	Case Type	Connections	Dimensions			Mounting Dimensions		Wt. Lbs.
		Volts	Amps					H	W	D	MW	MD	
A	F-57X	25.2 CT	1.000	117	1,500	X	Leads	1 ⁵ / ₁₆	3 ³ / ₁₆	2	2 ³ / ₁₆	•	1.50
	F-357X	25.2 CT	1.000	115/230	1,500	X	Leads	1 ⁵ / ₁₆	3 ³ / ₁₆	2	2 ³ / ₁₆	•	1.50
	F-41X#	25.2 CT	2.000	115	1,500	X	Leads	2 ⁹ / ₃₂	4	2 ¹ / ₄	3 ³ / ₁₆	•	2.20
	F-341X	25.2 CT	2.000	115/230	1,500	X	Leads	2 ⁹ / ₃₂	4	2 ¹ / ₄	3 ³ / ₁₆	•	2.20
	F-56X	25.2 CT	2.800	115	1,500	X	Leads	2 ⁹ / ₃₂	4	2 ¹ / ₄	3 ³ / ₁₆	•	2.50
B	F-119X	26.8 CT	0.150	115	1,500	X	Leads	1 ¹ / ₈	2 ³ / ₈	1 ¹ / ₂	2	•	0.45
	F-40X#	26.8 CT	1.000	115	1,500	X	Leads	1 ⁵ / ₁₆	3 ³ / ₁₆	2	2 ³ / ₁₆	•	1.30
	F-340X	26.8 CT	1.000	115/230	1,500	X	Leads	1 ⁵ / ₁₆	3 ³ / ₁₆	2	2 ³ / ₁₆	•	1.30
	F-55X	26.8 CT	1.700	115	1,500	X	Leads	2 ⁹ / ₃₂	4	2 ¹ / ₄	3 ³ / ₁₆	•	2.30
	F-355X	26.8 CT	1.700	115/230	1,500	X	Leads	2 ⁹ / ₃₂	4	2 ¹ / ₄	3 ³ / ₁₆	•	2.30
C	F-122X	28.0 CT	0.175	115	1,500	X	Leads	1 ¹ / ₈	2 ³ / ₈	1 ¹ / ₂	2	•	0.35
	F-124X	28.0 CT	0.800	115	1,500	X	Leads	1 ⁵ / ₁₆	3 ³ / ₁₆	2	2 ³ / ₁₆	•	1.00
	F-184X	28.0 CT	1.000	115	1,500	X	Leads	2 ⁷ / ₁₆	3 ³ / ₁₆	2 ¹ / ₄	3 ³ / ₈	•	1.40
	F-3185U	28.0 CT	2.000	115/230	1,500	X	Leads	3 ³ / ₁₆	2 ¹ / ₂	2 ⁷ / ₁₆	2	2 ¹ / ₄	2.90
	F-187U	28.0 CT	4.000	115	1,500	U	Leads	3 ¹ / ₂	2 ⁷ / ₈	3 ³ / ₁₆	2 ¹ / ₄	2 ¹ / ₄	5.30
D	F-188X	35.0 CT	0.100	115	1,500	X	Leads	1 ¹ / ₈	2 ³ / ₁₆	1 ¹ / ₁₆	2 ³ / ₈	•	0.35
	F-228X#	35.0 CT	0.300	115	1,500	X	Leads	1 ¹ / ₈	2 ³ / ₁₆	1 ¹ / ₈	2 ³ / ₈	•	0.60
	F-189X	35.0 CT	0.500	115	1,500	X	Leads	2 ⁷ / ₁₆	3 ³ / ₁₆	1 ³ / ₁₆	3 ³ / ₈	•	1.00
	F-54X	35.0 CT	1.500	115	1,500	X	Leads	2 ⁹ / ₃₂	4	2 ¹ / ₄	3 ³ / ₁₆	•	2.20
	F-354X	35.0 CT	1.500	115/230	1,500	X	Leads	2 ⁹ / ₃₂	4	2 ¹ / ₄	3 ³ / ₁₆	•	2.20
	F-191U	35.0 CT	4.000	115	1,500	U	Leads	3 ³ / ₁₆	3 ³ / ₁₆	3 ³ / ₁₆	2 ¹ / ₄	2 ¹ / ₂	6.00
	F-268U	35.0 CT	8.000	115	1,500	U	Leads	4 ¹ / ₂	3 ³ / ₄	4 ¹ / ₄	3	3 ³ / ₄	11.00
E	F-270X	40.0 CT	1.000	115	1,500	X	Leads	2 ⁷ / ₁₆	4	2 ¹ / ₄	3 ³ / ₁₆	•	2.60
	F-271U	40.0 CT	2.000	115	1,500	U	Leads	3 ³ / ₈	2 ³ / ₁₆	2 ³ / ₈	2 ¹ / ₄	2 ³ / ₈	4.00
	F-272U	40.0 CT	4.000	115	1,500	U	Leads	3 ³ / ₄	3 ³ / ₈	3 ¹ / ₂	2 ¹ / ₂	2 ³ / ₈	6.40
	F-273U	40.0 CT	6.000	115	1,500	U	Leads	4 ¹ / ₂	3 ³ / ₄	4	3	3	10.00
	F-275U	40.0 CT	10.000	115	1,500	U	Leads	5 ³ / ₈	4 ³ / ₈	4 ¹ / ₂	3 ¹ / ₂	3 ³ / ₈	14.50
F	F-59X	60.0 CT	0.400	115	1,500	X	Leads	1 ⁵ / ₁₆	3 ³ / ₁₆	2	2 ³ / ₁₆	•	1.30
	F-279U	60.0 CT	1.000	115	1,500	U	Leads	3	2 ¹ / ₂	2 ³ / ₈	2	2 ³ / ₈	3.40
	F-280U	60.0 CT	2.000	115	1,500	U	Leads	3 ³ / ₄	3 ³ / ₈	3 ³ / ₈	2 ¹ / ₂	2 ³ / ₈	5.60
	F-282U	60.0 CT	6.000	115	1,500	U	Leads	5 ³ / ₄	4 ³ / ₈	4 ³ / ₈	3 ¹ / ₂	2 ³ / ₈	12.50

60 Hz CT = Center Tap Mounting hole sizes: X = ³/₁₆" U = ¹/₆₄" x ³/₈"

:: Multiple Secondary

Section	Type No.	Secondary		Primary Voltage	RMS Test Voltage (Sec.)	Case Type	Connections	Dimensions			Mounting Dimensions		Wt. Lbs.
		Volts	Amps					H	W	D	MW	MD	
G	F-235Z#	12.0 CT	0.250	115	1,500	Z	Lugs	2	2 ³ / ₈	1 ¹ / ₁₆	2	•	0.6
		12.0 CT	0.250										
	F-236Z#	12.0 CT	0.500	115	1,500	Z	Lugs	2 ⁷ / ₁₆	2 ³ / ₈	1 ¹ / ₈	2 ³ / ₈	•	0.9
		12.0 CT	0.500										
		12.0 CT	1.000										
H	F-241U#f	18.0 CT	1.000	115	1,500	U	Lugs	2 ¹ / ₂	3	2 ¹ / ₂	2 ¹ / ₂	2	2.2
		18.0 CT	1.000										
	F-243U#f	18.0 CT	4.000	115	1,500	U	Lugs	3 ¹ / ₂	4 ³ / ₈	3 ³ / ₄	3 ³ / ₁₆	2 ¹ / ₄	5.2
		18.0 CT	4.000										
		18.0 CT	8.000										
F-244U#f	18.0 CT	8.000	115	1,500	U	Lugs	3 ³ / ₄	4 ¹ / ₂	4	3 ³ / ₄	2 ³ / ₄	8.3	
	18.0 CT	8.000											
I	F-195X	32.0 CT	0.250	115	1,500	X	Leads	2 ¹ / ₄	3 ³ / ₄	1 ¹ / ₈	3 ³ / ₈	•	1.3
J	F-196U	32.0 CT	1.000	115	1,500	U	Leads	3 ³ / ₈	2 ³ / ₁₆	2 ³ / ₈	2 ¹ / ₄	2 ¹ / ₄	4.0
		15.5 CT	2.000										
K	F-197U	32.0 CT	1.000	115	1,500	U	Leads	3 ³ / ₄	3 ³ / ₈	2 ⁷ / ₁₆	2 ¹ / ₂	2 ¹ / ₄	4.7
L	F-198U	32.0 CT	1.000	115	1,500	U	Leads	3 ³ / ₄	3 ³ / ₈	3 ³ / ₁₆	2 ¹ / ₂	2 ¹ / ₄	6.2
		15.0 CT	6.000										

f Windings may be connected in series to obtain their combined voltage when properly phased. Current will be equal to the current of the lowest winding. Example: Two 6.3 V windings @ 2A in series would be 12.6 V @ 2A. Windings may also be connected in parallel to obtain combined current. Example: Two 6.3 V windings @ 2A in parallel would be 6.3 V @ 4A. # 60 Hz CT = Center Tap Mounting hole sizes X = ³/₁₆" U = ¹/₆₄" x ³/₈" Z = ³/₁₆"